

Theo25

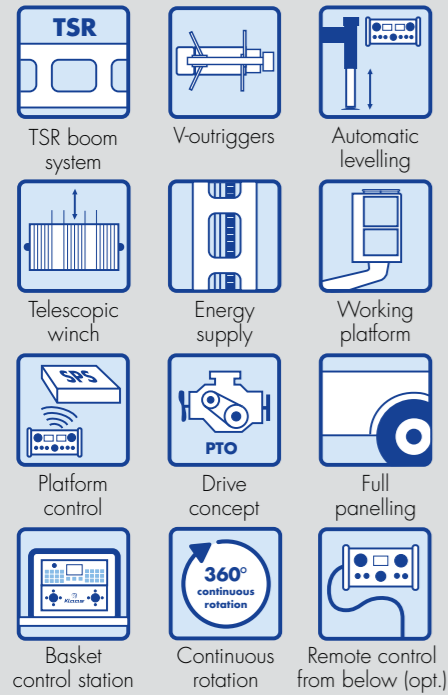

Equipment



Working Range Diagram — 100 kg — 200 kg — 250 kg

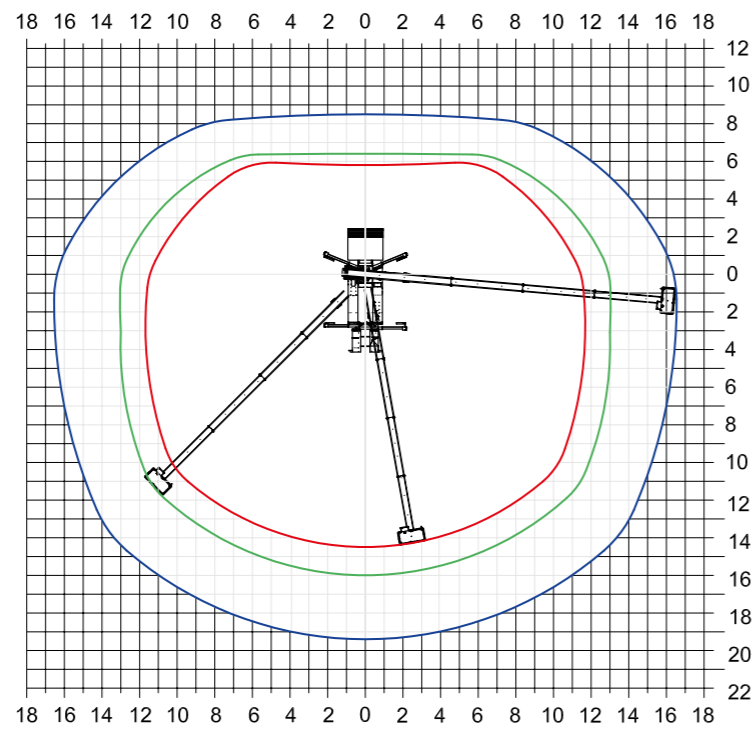

Technical specifications

Working height	25.00 m
Range to the rear (100 kg)	19.30 m
Range to the side (100 kg)	17.00 m
Swivel range	continuous rotation
Work basket angle of rotation	180°
Basket capacity	250 kg
Large work basket	1.4 m x 0.7 m
Outrigger width (min.)	2.24 m
Outrigger width (max.)	at the front 4.26 m at the back 4.25 m
Total weight** (min.)	3.5 t

**depending on truck type

Range to the rear

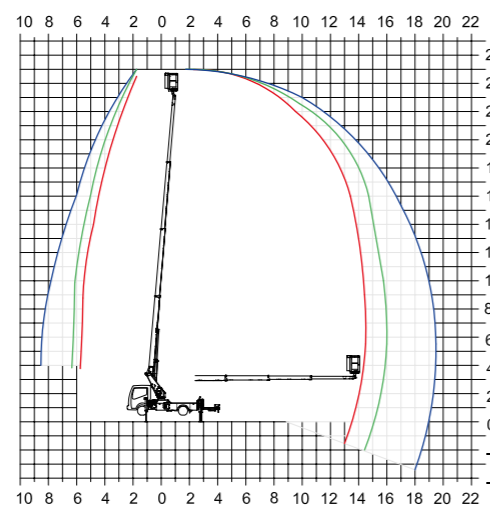

Range to the right

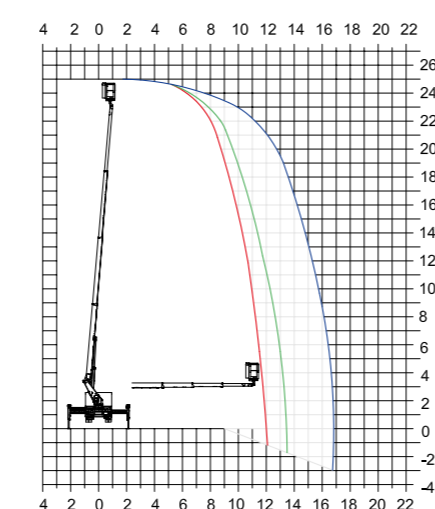



25 m working height

19 m working radius

Continuous rotation

Patented rope technology



  Kranlyft UK Ltd, Unit 1, IO Centre, Cabot Park, Avonmouth, Bristol, BS11 0QL
Tel: +44 (0)117 982 6661 Fax: +44 (0)117 982 9173
info@kranlyft.co.uk

  Fibervägen 1, SE-435 33 Mölnlycke
Tel: +46 31 80 70 00 Fax: +46 31 15 97 72
info@kranlyft.com

Subject to technical changes. All specifications are approximate. Changes to the functions and services are reserved. The information reflects the device performance at the time of printing.

Theo25

Alu-Power by  **Klaas**

The high-performance Klaas elevating work platforms, Theo20 and Theo25, benefit from our decades of experience in the development of mobile cranes with aluminium booms and work platform function. Thanks to their simple handling and sophisticated technology, they can be quickly and conveniently set up and dismantled using the control console. The low-

maintenance rope technology enables telescoping under load, meaning that even difficult to access work areas can easily be reached. The Theo with its working height of 25 m plus its enormous reaches to the rear and to the side, not only makes work easier for roofers, building cleaners and assembly firms. The platform can also be used efficiently in a variety of ways

for facade engineering and horticultural purposes. Set up on a sturdy Nissan Cabstar, it meets the Euro 6 emissions standard and can thus be used without hesitation in the inner-city area.



Basket control station

- High-quality basket control station in terms of ergonomics and feel, optimally adapted to the operator's needs
- Easy to operate thanks to direct selection of important functions and clear presentation
- Extremely sensitive joysticks for precisely controlling the platform
- Informative, large colour display clearly showing all key platform operating statuses
- With integrated plastic protective cover



TSR

TSR boom system

- Boom with continuous rotation
- Extremely strong and weather-resistant aluminium special alloy with low net weight
- No strength loss in the welding seam due to new stir welding process, joints are as strong as the solid material
- Quick telescoping under load thanks to patented Klaas rope technology
- Extremely low-maintenance and durable rope technology



Working platform

- Ability to get in and out at front and back via a self-closing door
- Work basket rotates by 90° to each side using a joystick
- 230 V socket for power tools
- Lashing points conforming to standards for the PPE directly in the work platform



V-outriggers

- Fully hydraulic outriggers in conjunction with ASC support monitoring system enables variable outrigger widths, even in the direction of the range of action
- No fixed increments that restrict the operator
- Optimal user protection thanks to constant monitoring of the stability
- Integral hydraulic lines to outrigger beams, thus protection against damage from falling objects.

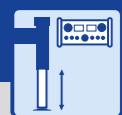

Automatic levelling

- Quick and easy set-up and dismantling via the control console
- Fully variable outrigger extension
- Self levelling outrigger set-up even on uneven surfaces
- Constant pressure monitoring reacts to changing outside conditions



Platform control

- Ultra-modern safety control system (PLC) for operating the platform according to DIN EN 280
- Modern CAN BUS control block for particularly sensitive and accurate work
- Soft start/stop, levelling cylinders and luffing cylinders provide for low-vibration work
- Optional control of all key basket functions via second cable remote control from below
- Freely selectable angle of rotation presetting
- Freely selectable reach and height presetting



Drive concept

- Platform operated by powerful truck engine with auxiliary drive (PTO)
- Modern controller and electrical components enable standstill whilst set up for up to four hours
- Electronic fuel level monitoring via control console



Telescopic winch

- Quick telescoping under load thanks to patented Klaas rope technology
- Low net weight of the ropes increases range of action and payload
- Low-maintenance and very easy to reach rope technology
- Highest safety thanks to double rope guide



Full panelling

- Completely closed full panelling made of anodised aluminium smooth plate
- Lockable doors and hoods ensure inaccessibility to various components
- High-quality design due to full panelling

Euro6-Norm

- Modern carrier vehicle meets the Euro 6 emissions standard without hesitation in the inner-city area